

CUSTOMWORKS ENFORCER GBX3 PRO-COMP

INSTRUCTIONS



#0923 ENFORCER GBX3 RACING KIT

Manufactured By:

www.customworksrc.com

CUSTOMWORKS
R/C CARS

760-B Crosspoint Drive
Denver, NC 28037

www.customworksrc.com



REQUIRED READING...UNDERSTAND THIS MANUAL!

Thank You and Congratulations on purchasing the **ENFORCER GBX3!** Within this kit you will find a race winning car with over 25 years worth of **CUSTOM WORKS** design and quality. In order for you to realize this race car's winning potential it is important to follow the written text along with the pictures included. The steps required to build this car are very easy, as long as you read before you build.

The instructional format for building this car is to open each bag in alphabetical order. Each bag of parts will be broken down into "Steps" thru the manual. All parts and hardware needed to complete all steps for each separate bag, will be found in each individual bag. There is no need to steal screws from other bags. In the rare event you need to look in a different bag for a certain part, it will be noted clearly in the instructions.

Considering the various dirt or clay surfaces that Dirt Oval cars are raced on today, the Enforcer GBX3 has been designed to be competitive on high bite and well groomed clay tracks with rubber or foam racing tires. The instructions will build the kit using the most verastale set-up Custom Works has found in testing on different types of tracks, however there are various other suspension configurations available to you that you may find more suitable for your local track. For updates and more proven set-ups login to CustomWorksRC.com.

All hardware (screws, washers, nuts, etc...) are referred to by size and type in the instructions. To help clarify which screw or nut the instruction is calling for refer to the **HARDWARE REFERENCE** supplement. The size of the screw or nut should match the "shadow" of the same piece very closely.

Screw ID's are: **FH**=Flat Head **BH**=Button Head **SH**=Socket Head **SS**=Set Screw

BUILDING TIPS:

-Parts are made with tight tolerance and held to the side of a "snug" fit as wear is expected over time. Try as we may, occasionally a burr may remain in a part and fit more tightly than desired. It is ok to use 400 Grit Sandpaper or a .125" drill to **SLOWLY** relieve a part from time to time. Suspension components should always pivot and swivel freely but not sloppily.

-Using some type of thread locking fluid is suggested for all parts where metal screws thread into other metal parts. We suggest using a lite setting strength thread lock for the reason you may want to take the screw out one day. Remember it only takes a very small amount to secure the screw.

-Do **NOT** use power screwdrivers to drive screws into parts. The fast rotation speed can easily melt and strip plastic parts or cross-thread into the aluminum parts.

-Lightly sand the edges of graphite pieces using a medium grade sandpaper to avoid splinters. Run a thin bead of Super Glue around the edges to give pieces greater durability.

SUGGESTED TOOLS

400 Grit Sandpaper

Hobby Scissors

Small Needle Nose Pliers

Wire Cutters

X-Acto Knife

Phillips Head Screw Driver

Blue Loctite

3/16" Wrench

Bag A Front Suspension



-Parts for Step#1		Qty 1		Qty 2		Qty 2		Qty 4		Qty 4		Qty 2		Qty 24		
-Parts for Step#2		Qty 1		Qty 1		Qty 1		Qty 1		Qty 1		Qty 2		Qty 4		Qty 1

STEP #1

USE HIGH OPTION ON ALUM MOUNT

5212 Spacer goes between the Susp Arm and the 3258 Mount

2320

5284 GOES THRU ARM & THRU "INSERT" LIKE A SCREW...

- Insert 4240 Inner Pin thru 3332 Susp Brace and thru the first leg of 3253 Susp Arm. The 5212 Spacer will go between the Susp Arm and the 2320 Susp Mount.
- Snap 5230 E-Clips to 4240 Susp Pin.
- Arms should pivot freely on the mounts.

STEP #2

3228 SET SCREW

3314

1297

MIDDLE INNER Screw Mounting Locations for 2320 Suspension Mounts

5253

5263

3229

- Fasten the 1297 tower to the suspension assembly. THE REMAINING HOLES WILL BE COMPLETED IN "Bag B"!
- Fasten the suspension assembly and the 3228 Body Post to the 3314 Chassis as shown above.

Bag B Steering Components



-Parts for Step#1		Qty 3		Qty 2		Qty 1		Qty 7		Qty 2		Qty 2		
-Parts for Step#2		Qty 2		Qty 2		Qty 2		Qty 6		Qty 4		Qty 5		Qty 2
-Parts for Step#3		Qty 1		Qty 1		Qty 1		Qty 2		Qty 4		Qty 1		Qty 1
		Qty 2 (Left Shown)		Qty 2		Qty 2		Qty 5		Qty 10		Qty 4		Qty 24
		Qty 1		Qty 2		Qty 2		Qty 4		Qty 5		Qty 4		

STEP #1

Makes (2) "Front Camber Links"

5213

5223

5235

5235

5223: Makes "LF Steering Link"
5225: Makes "Rear Camber Links"
5226: Makes "RF Steering Link"

- Press the 5213 Pivot Ball into the Ball End.
- Thread the 5235 Ball Cups and 5213 Ball End onto the ends of (2) of the 5223 Turnbuckles.
- Thread the 5235 Ball Cup onto the ends of the (1) 5223 Turnbuckle, (2) 5225 Turnbuckle, and (1) 5226 Turnbuckle

STEP #2

- Insert the 7224 Axle into the 3213 Steering Arm so the holes are in-line. This can be tricky with the angled hole. Once aligned, you may pass a .125 drill bit thru SLOWLY to assure the 7209 will pass thru.
- Mount the 1292 Steering Arm Extender to the Steering Arm using 5253 Screws.
- Attach the 8122 Ball Stud in the MIDDLE option on the each spindle.
- Mount the 3400 Castor Block to the Susp Arm by inserting the 4241 Susp Pin thru the Susp Arm, Spacer, and Castor Block. Retain the Susp Pin by attaching 5292 to each end of the susp arm.
- Align the Steering Arm into the 3400 Castor Block and press the 7209 Ball Stud Kingpin thru the assembly as shown.
- Use the remaining 7209 Spacers and E-Clip the Ball Stud King pin to retain within the Castor Block assembly.

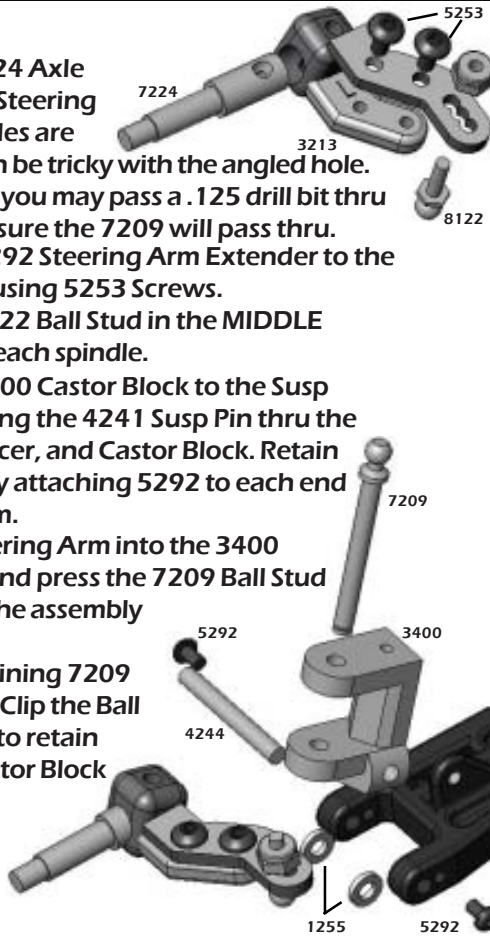

STEP #3

- Assemble the bell crank as shown in the diagram to the left. Use the thin shims on the 3646 Steering Post so there is ZERO slop with the movement of the bellcrank.
- Fasten the Steering Post to the chassis using 5263 screw and Loctite on the screw threads.
- Mount the "Front Camber Links" from Step #1 to the front of the shock tower using 5257 screw with 2219 Standoff as shown in diagram in the lower left. Snap the ball cup onto the 7209 Ball Stud King Pin.
- Snap RIGHT and LEFT Steering Links to the ball studs on the spindle and the bottom of the bell crank.
- Attach the 5240 Servo Mounts to your servo with 5253 Screws and 5212 Washers so that it will mount in the position shown.
- Mount the servo to the chassis using (2) 5263 screws.



Bag C Rear Suspension

-Parts for Step#1



-Parts for Step#2



STEP #1

- Attach the 1284 Long Shock Ears to the 1273 Bulk to the side facing away in the diagram.
- Attach the 3305 Tail Tank Tray as shown in the diagram.

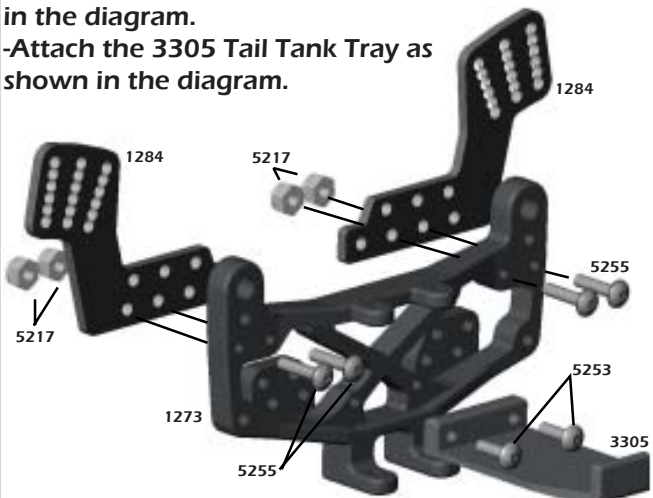

STEP #2

- Attach the 3254 Susp Arm to the 2222 Toe Block using the 4247 Susp Pin. Retain the pin with 5292 Screws.

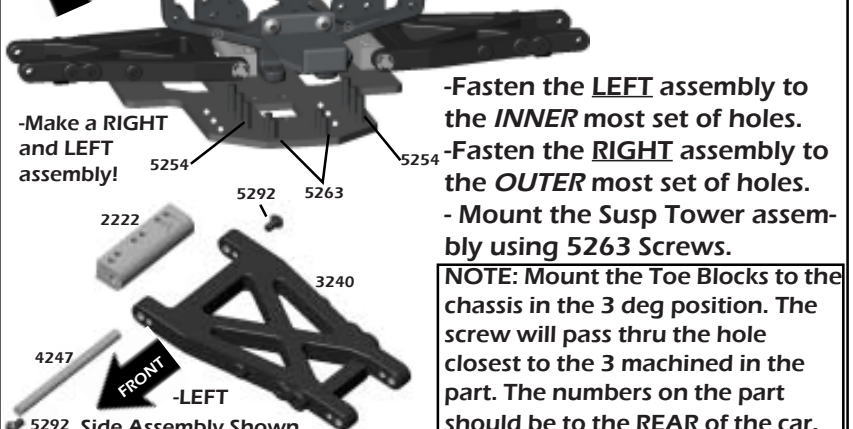

Bag D Rear Suspension



-Parts for Step#1	3241 Qty 2 Bearing Carrier	1226 Qty 4 Ball Bearing	4245 Qty 2 Rear Outer Susp Pin	1255 Qty 10 Spacer	5292 Qty 4 M2.5 x 4 BH Screw	
-Parts for STEP#2	7211 Qty 2 CVD Coupling	7213 Qty 1 Short Dogbone	7214 Qty 1 Medium Dogbone	7216 Qty 2 Rear CVD Axle	7211 Qty 2 Rear CVD Pin	7211 Qty 2 CVD Set Screw
-Parts for STEP#3	5225 Qty 2 2" TI Turnbuckle	5235 Qty 4 Ball Cup	7047 Qty 8 Spacer	8122 Qty 4 Ball Stud	7203 Qty 2 Roll Pin	5217 Qty 2 4-40 Lock Nut

STEP #1

- Press 1226 Ball Bearings into the 3241 Bearing Carrier.
- Attach the Bearing Carrier to the Susp Arm using 4245 Susp Pin with (2) 1255 Spacers on each side of the Bearing Carrier.
- **NOTE: The Suspension Pin will pass thru the UPPER hole in the Bearing Carrier.**
- Retain the Susp Pin using 5292 Screws.

STEP #2

- Apply grease to the areas shown.
- Apply thread-lock (Loctite) to the set screw.
- Align the holes as shown so that the 7211 CVD Pin can pass thru the Bone, Axle, and Coupling. Pin should be evenly spaced in the DogBone.
- Tighten the Set Screw by angling the Bone and Axle so the set-screw is able to be tightened.

STEP #3

- Assemble the camber links by threading the 5235 Ball Cup on each end of the 5225 Turnbuckle. Attach by snapping the Ball Cups onto the Ball Studs.

- Attach the 8122 Ball Stud to the Rear Bulkhead as shown using a 5217 Lock Nut.

- Slide the thick shim packaged with the CVD parts onto the CVD Axle, Insert the CVD assembly by sliding the axle thru the bearings.

- Slide a 1255 Spacer onto the Ball Stud and thread into the Bearing Carrier in the outer most hole.

- Slide (4) 7047 Shims onto the axle and retain using the 7203 Roll Pin. Pin should be evenly spaced in Axle.

TYPICALLY FOR THE ENTIRE AXLE (2) OF THE THICK AND (2) OF THE THIN #7047 SHIMS WILL SUFFICE FOR PROPER AXLE SHIMMING.

Bag E Diff Assembly



-Parts for Step#1							
	4365 Qty 1	4358 Qty 2	4360 Qty 2	4361 Qty 1	4359 Qty 6	4361 Qty 1	1229 Qty 2
-Parts for Step#2							
	4364 Qty 1	4362 Qty 1	4356 Qty 1	4363 Qty 12	4361 Qty 1		

STEP #1

CUSTOM-TIP!!!
 -Using 400 Grit Sandpaper in a "Figure 8" pattern, it is best to sand the surfaces of both the 4358 Diff Ring and 4360 Thrust Washers. The textured surface results in a smoother and longer lasting diff.

- Slide a 4360 Thrust Washer onto the Diff Bolt.
- Apply a thick layer of Black Grease to the Thrust Washer, press (6) 4359 Thrust Balls into the Black Grease.
- Slide the other Thrust Washer on the Diff Bolt and insert it into the 4365 Right Outdrive.
- Press (1) 1229 Bearing into the Outdrive.
- Put (1) 4358 Diff Ring on the Outdrive, apply Diff Lube as shown.

STEP #2

- Press a small amount of Diff Grease into each of the small holes in the 4356 Diff Gear.
- Press (1) 1229 Bearing and the (12) 4363 Diff Balls into the Diff Gear.
- Put (1) 4358 Diff Ring onto the 4364 Left Outdrive, apply Diff Grease as shown.
- Install the 4362 Diff Spring and 4361 T-nut into the Outdrive.
- Carefully slide the diff assembly together so the Diff Bolt passes thru the entire assembly and threads into the T-nut.
- Screw the Diff Bolt into the T-nut until you feel the Diff Spring fully compress. **DO NOT OVERTIGHTEN!!!**
- Back the Diff Bolt off EXACTLY 1/8 of a turn. Diff motion should be smooth and the Outdrives will turn in opposite directions.

Bag F Transmission Casing



-Parts for Step#1 & Step#2								
	4352 Qty 1	4352 Qty 1	4354 Qty 1	4355 Qty 1	4370 Qty 6	7047 Qty 8	1230 Qty 2	1226 Qty 4
	4368 Qty 1	5291 Qty 3	5263 Qty 4	4406 Qty 1	4352 Qty 3	2225 Qty 1		

STEP #1

- Press the bearings into the 4352 Trans Case and 4354 Idler Gear as shown.
- Slide 4370 Washers on each side of the 4368 Top Drive Shaft:
 *THICK Shim on short shaft
 *THIN Shim on short shaft
- Insert components as shown inside the case halves.
 *Screw for the Diff should be on the RIGHT side!
 *Use a tiny amount of diff lube on trans gears!

- Use diff lube on trans gears!!!

- Press the 4406 Pin into the Drive Shaft.
- Fasten trans using 2225 Motor Plate using the hole-set option as shown and the 5263 Screw in the bottom.

- Diff Screw should be on the RIGHT side of the Trans!

Bag G Spur Gear Assembly



-Parts for Bag G		2228 Qty 1 Slipper Eliminator		4881 Qty 1 81T 48P Spur Gear		5252 Qty 1 4-40 x 1/4 BH Screw		2228 Qty 1 Spacer		5245 Qty 1 5-40 Locknut

- Press the 2228 Slipper Eliminator onto the Top Drive Shaft so that the Roll Pin keys into the grooves.
 - Secure the assembly to the Top Shaft with the 2228 Spacer and the 5245 Locknut. Do NOT overtighten the nut on the Top Shaft!
 - Mount the 4881 Spur Gear so the flat side faces AWAY from the transmission. Secure using (2) 5252 Screws.

Bag H Transmission Mount



-Parts for Bag I		3308 Qty 1 Transmission Brace		3229 Qty 1 Post Collar		1202 Qty 1 Trans Spacer		3229 Qty 1 8-32 x 1/2 FH Screw		5262 Qty 1 4-40 x 1/4 FH Screw
				3229 Qty 1 Short Body Post		3229 Qty 1 Set Screw		5264 Qty 2 4-40 x 1/2 FH Screw		5253 Qty 4 4-40 x 3/8 FH Screw

- Attach 3229 Body Post to 3308 Trans Brace using 3229 Screw.
 - Slide 3201 Post Collar onto the Body Post and secure using 3229 Set Screw.
 - Mount the 1202 Trans Spacer to the Chassis using the 5262 Screw where shown.
 - Secure the Trans to the Chassis using (2) 5264 Screws thru the 1202 Trans Spacer as shown.
 - Attach the 3308 Trans Brace to the Trans and Rear Bulkhead using 5253 Screws.
 - NOTE: Align the dogbone shafts into the outrdrives of Trans as you mount it to the chassis!

Bag I Battery Mount







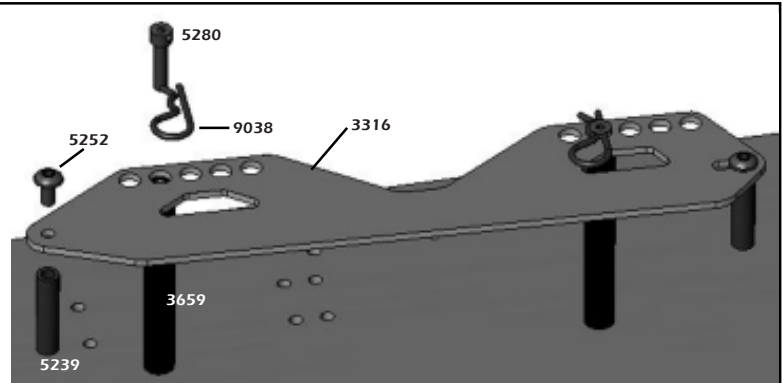

















-Parts for Bag I		3316 Qty 1 Batt Bracket w/Foam		3659 Qty 2 Batt Post		5280 Qty 2 Hole Head Screw SHORT		5239 Qty 2 Post		9038 Qty 2 Retaining Clip		5252 Qty 2 4-40 x 1/4 BH Screw		5253 Qty 2 4-40 x 3/8 FH Screw		5263 Qty 2 4-40 x 3/8 FH Screw

- Attach 3659 Battery Posts to the chassis using either 5253 or 5263 Screws.
- Thread 5280 Hole Head Screws into the top of the Battery Posts mounted to the chassis.
- Mount the 5239 Post on the slotted end of the 3316 Battery Bracket using 5252 Screws. (Slotted hole is to adjust for varying battery lengths)
- Attach the remaining 3659 to the front of bracket.
- Stick the supplied foam tape to the under-side of the battery bracket.
- Align the Battery Bracket over the Hole Head Screw for the desired location and secure using 9038 Clip.



Shock Bag Shock Assembly



-Parts for Step#1	 1425 Med / 1426 Short Qty 2ea 2 Med / 2 Short Shock Body	 1429 Med / 1430 Short Qty 2ea 2 Med / 2 Short Shock Shaft	 1434 Qty 4 Shaft Guide	 1250 Qty 8 O- Ring	 1435 Qty 8 Retaining Clip	 1436 Qty 4 Piston	 5230 Qty 10 E-Clip			
-Parts for Step#2	 1438 Qty 4 1 Piece Cap	 1437 Qty 4 Bladder	 1433 Qty 4 Spring Collar	 5235 Qty 2 Ball Cup	 5228 Qty 2 Short Ball End	 5228 Qty 2 Pivot Ball				
-Parts for Step#3	 1492 Qty 2 12# Spring	 1488 Qty 2 8# Spring	 1407 Qty 4 Spring Bucket	 1408 Qty 4 Mount Ball	 5212 Qty 4 Washer	 5277 Qty 4 4-40 x 7/8 SH Screw	 5274 Qty 2 4-40 x 1/2 SH Screw	 8122 Qty 2 Ball Stud	 2214 Qty 4 .250" Hex Spacer	 5217 Qty 4 4-40 Lock Nut

STEP #1

NOTE: Put a few drops of oil on the O-Rings!



Attach 1436 Shock Piston to Shock Shaft using 5230 E-Clips to secure.

Press 1250 O-rings into the Shock Body followed by 1434 Shaft Guide. Retain using 1435 Clip.

TIP: To press clip in easiest, compress the clip so the diameter is a little smaller. Insert open end of clip first, working counter-clockwise to the bent end as shown.

BUILD 2 SHORT & 2 MED LENGTH SHOCKS!

- USE #1429 SHAFT WITH #1425 BODY.
- USE #1430 SHAFT WITH #1426 BODY.

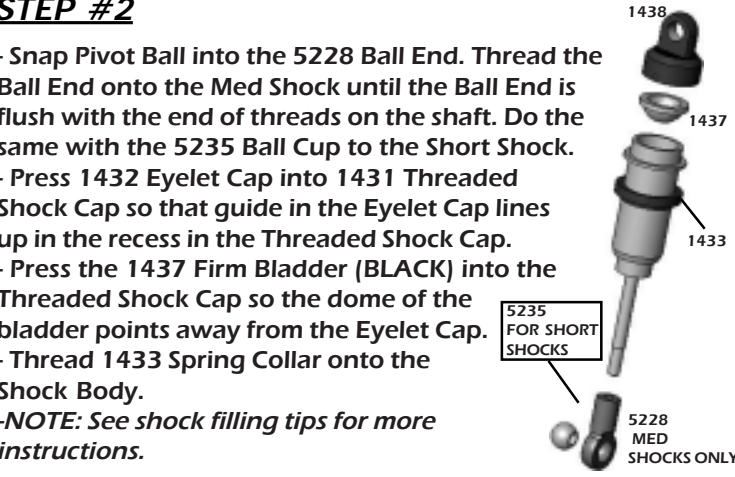

STEP #2



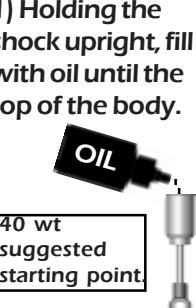

- Snap Pivot Ball into the 5228 Ball End. Thread the Ball End onto the Med Shock until the Ball End is flush with the end of threads on the shaft. Do the same with the 5235 Ball Cup to the Short Shock.
- Press 1432 Eyelet Cap into 1431 Threaded Shock Cap so that guide in the Eyelet Cap lines up in the recess in the Threaded Shock Cap.
- Press the 1437 Firm Bladder (BLACK) into the Threaded Shock Cap so the dome of the bladder points away from the Eyelet Cap.
- Thread 1433 Spring Collar onto the Shock Body.

-NOTE: See shock filling tips for more instructions.

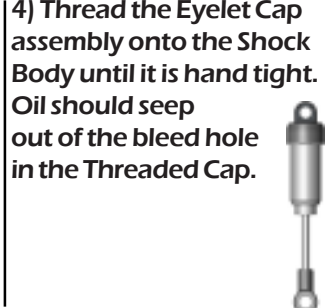
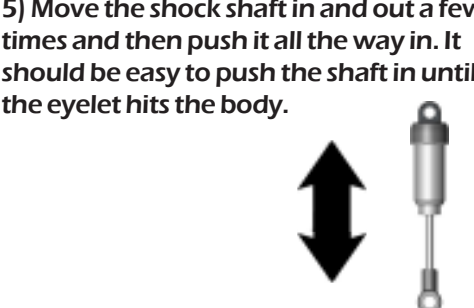
SHOCK FILLING INSTRUCTIONS:

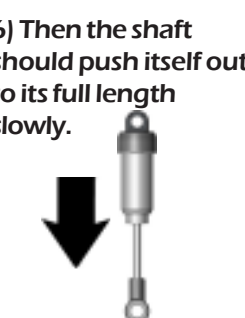
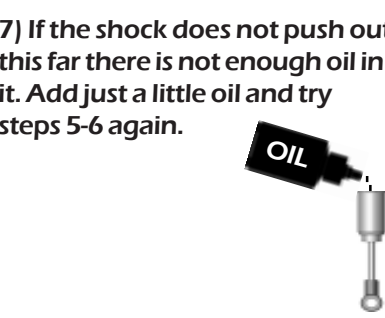
- Holding the shock upright, fill with oil until the top of the body.
 
- Slowly move the shaft up and down several times to allow air bubbles to escape to the top.
 
- Refill with oil to the top of the shock body.
 
- Thread the Eyelet Cap assembly onto the Shock Body until it is hand tight. Oil should seep out of the bleed hole in the Threaded Cap.
 
- Move the shock shaft in and out a few times and then push it all the way in. It should be easy to push the shaft in until the eyelet hits the body.
 

- Then the shaft should push itself out to its full length slowly.
 
- If the shock does not push out this far there is not enough oil in it. Add just a little oil and try steps 5-6 again.
 
- If the shock rebounds too fast, or you cannot push the shaft in until the eyelet hits the body, there is too much oil. Loosen the cap about 2 full turns and pump out a small amount of oil by pushing the shaft in. Retighten the cap and try steps 5-6 again.
 

STEP #3

- Slide 1488 Chrome Springs on the Med Shocks, the 1492 Orange Springs on the Short Shocks. Secure using the 1407 Spring Bucket.

REAR SHOCK: Insert 5277 Screw thru hole shown in rear tower. Thread 2214 onto the screw. Place shock over screw and retain with 1408 and Nut. Fasten the shock to the arm using 5274 Screw.

FRONT SHOCK: Insert 5277 Screw thru 5212 Washer and then thru the Shock Cap. Slide the Shock Eyelet over the screw and tighten the 2214 to it. Attach to the tower by holding the 2214 and fastening with the Locknut. Thread the 8122 to the arm as shown and snap the shock ball cup to it.

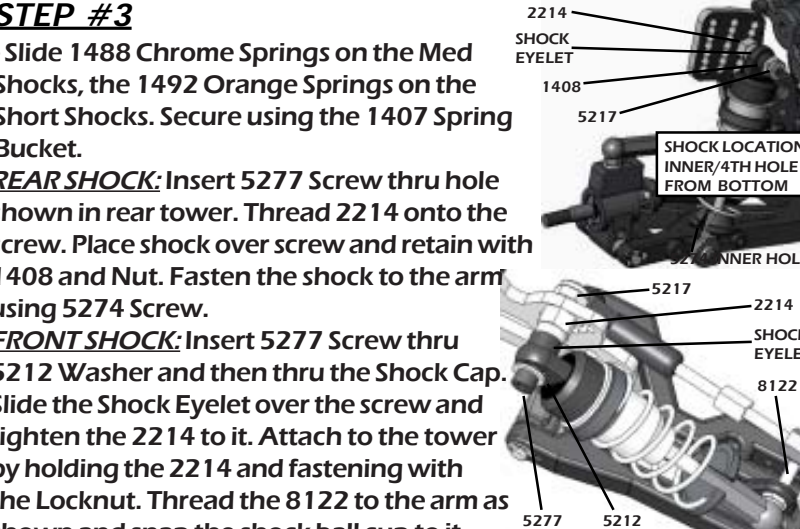

Cage Bag **Cage Assembly**



-Parts for Step #1 & Step #2							
	3233 Qty 2 Rear Bumper	3233 Qty 1 Bumper Connector	3239 Qty 1 Front Cage Mount	5255 Qty 4 4-40 x 5/8 BH Screw	5254 Qty 6 4-40 x 1/2 BH Screw	5253 Qty 2 4-40 x 3/8 BH Screw	5262 Qty 2 4-40 x 1/4 FH Screw
-Parts for Step #3 & Step #4							
	3235 Qty 2 Main Cage Half	3233 Qty 1 Front Bumper	3232 Qty 1 Nerf Bar L & R	3232 Qty 1 Nerf Support L & R	3235 Qty 2 Upper Cage Brace	3421 Qty 2 Wing Slide Bushing	
	5278 Qty 2 4-40 x 1" SH Screw	5279 Qty 2 Hole Head Screw LONG	5280 Qty 2 Hole Head Screw SHORT	5274 Qty 4 4-40 x 1/2 SH Screw	5264 Qty 3 4-40 x 1/2 FH Screw		

STEP #1

- Mount the (2) 3233 Rear Bumpers together using 5253 Screws and the 3233 Bumper Connector.

-Attach the Bumper Assembly to the Rear Bulkhead using 5255 Screw into the upper bumper and 5254 Screw into the lower bumper as shown.

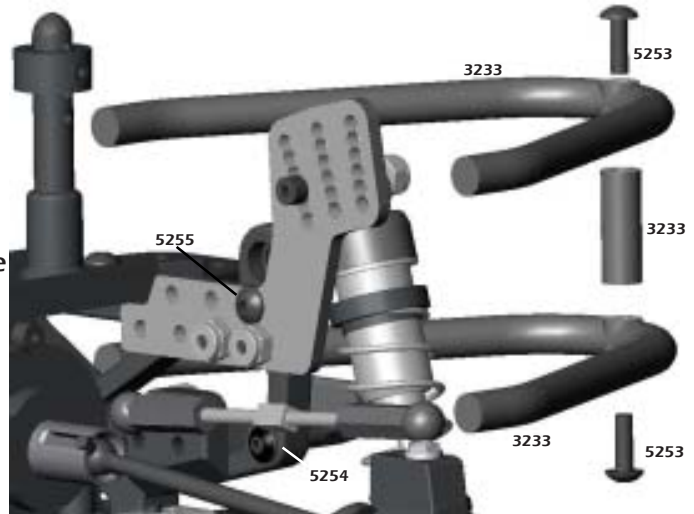

STEP #2

- Mount the 3239 Front Cage mount to the chassis using 5262 Screws.

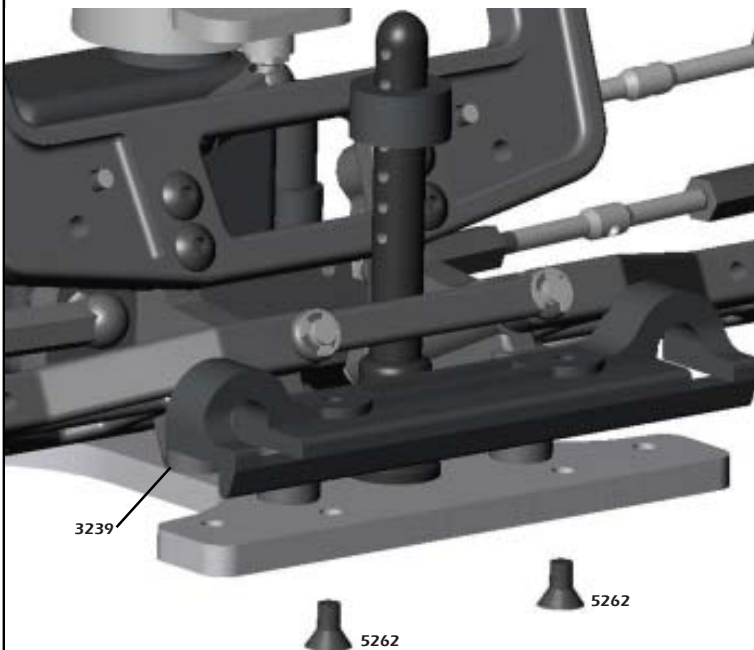

STEP #3

- Assemble the Nerf Bar and Nerf Bar Support using 5254 Screw.

NOTE: Right and Left Nerf Bars and Supports come in the cage kit. Shown is the RIGHT assembled part. When using the correct Support with the Nerf Bar, the bottom foot of the Support and the short leg of the Nerf Bar will be parallel.

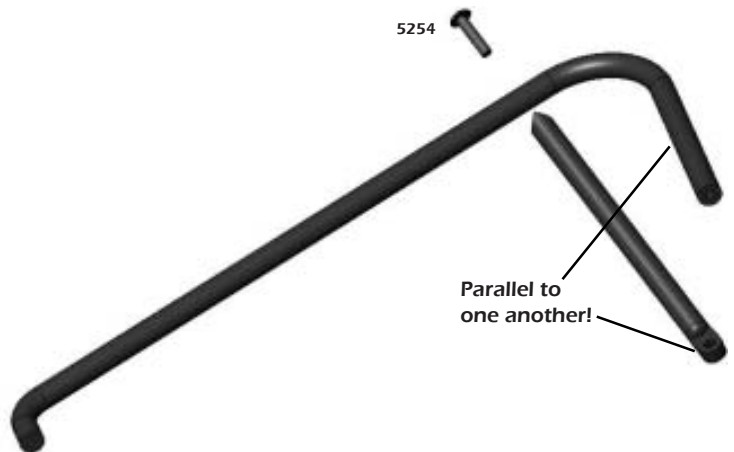

STEP #4

- Mount 3233 Front Bumper using 5278 Screws.
- Mount the 3421 Wing Slide Bushing to the Cage using 5254 Screws thru the Bushing and Cage and into the 3235 Upper Cage Brace.
- Use the (2) Long 5279 Hole Head Screws mount the 3235 Upper Cage Braces onto the top of the Main Cage Halfs.
- Use the remaining (2) Short 5280 Hole Head Screws in the back of the Main Cage Halfs.

NOTE: Do NOT tighten all the way down, leave a gap of .100" between the screw head and cage.

- After completing the Body Panel steps, Attach the rear of the Nerf Bar using the 5254 Screw thru the cage as shown. Attach the front of the Nerf Bar and the Nerf Bar Support to the bottom of the "legs" on the Main Cage Half using 5274 Screws.

NOTE: The 3421 Wing Slide Bushing is found in the "WING" bag.

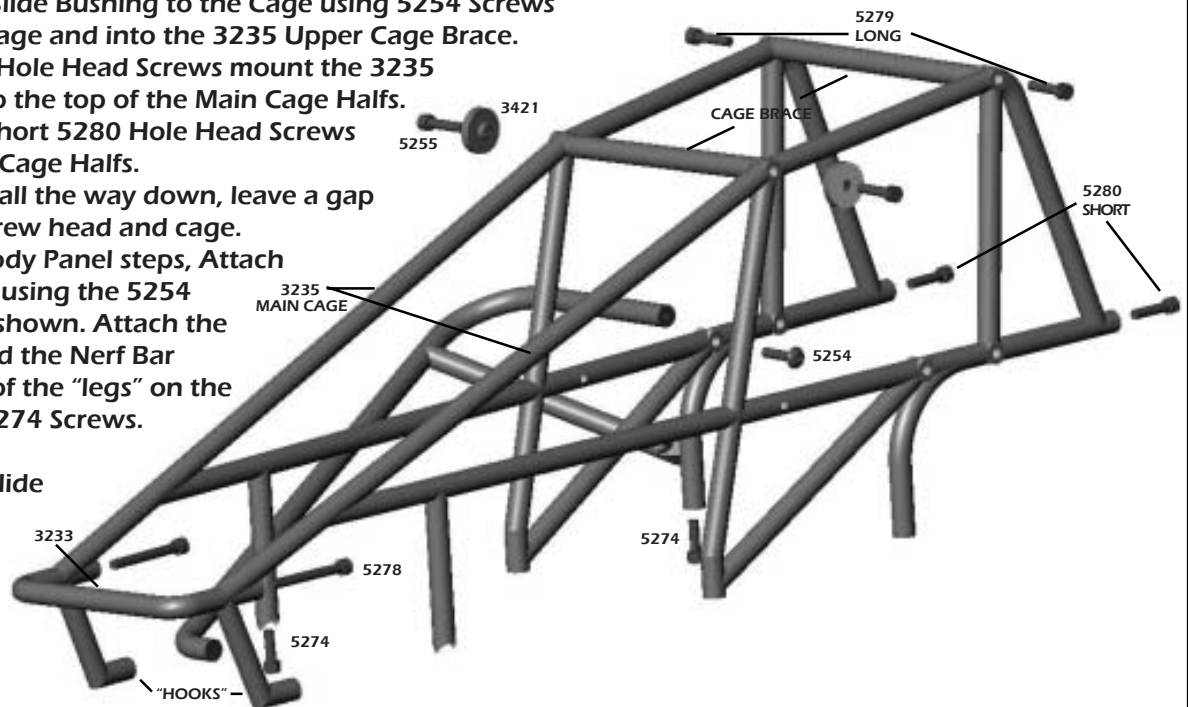

CAGE INSTALLATION AND REMOVAL:

- Place the cage between the front suspension tower with the "HOOKS" slightly further forward than the front edge of the chassis.
- Guide the "HOOKS" into the Front Cage Mount while guiding the Short 5280 Hole Head Screws into the Rear Bulkhead.
- Position the (2) 5274 Screws that mount the bottom portions of the nerf bars to the Cage Half into the holes in the Chassis.
- Lock the cage by placing 9936 Clip into the Hole in the Head of the 5280 Screw.

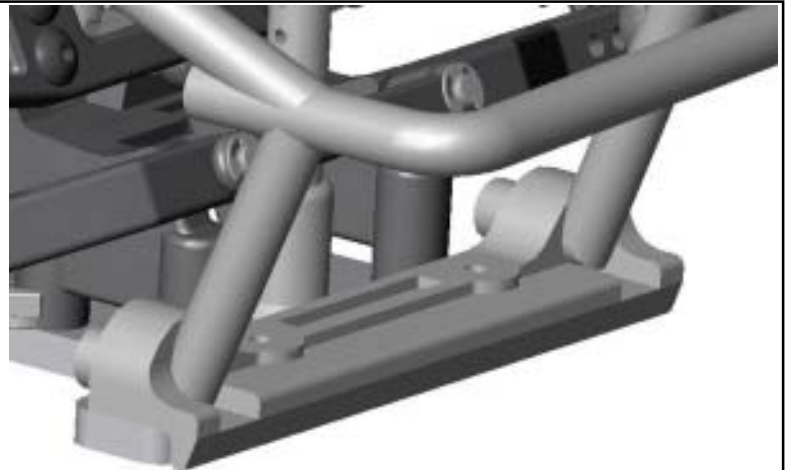

Body Panel Bag

Body Panel Prep & Mounting

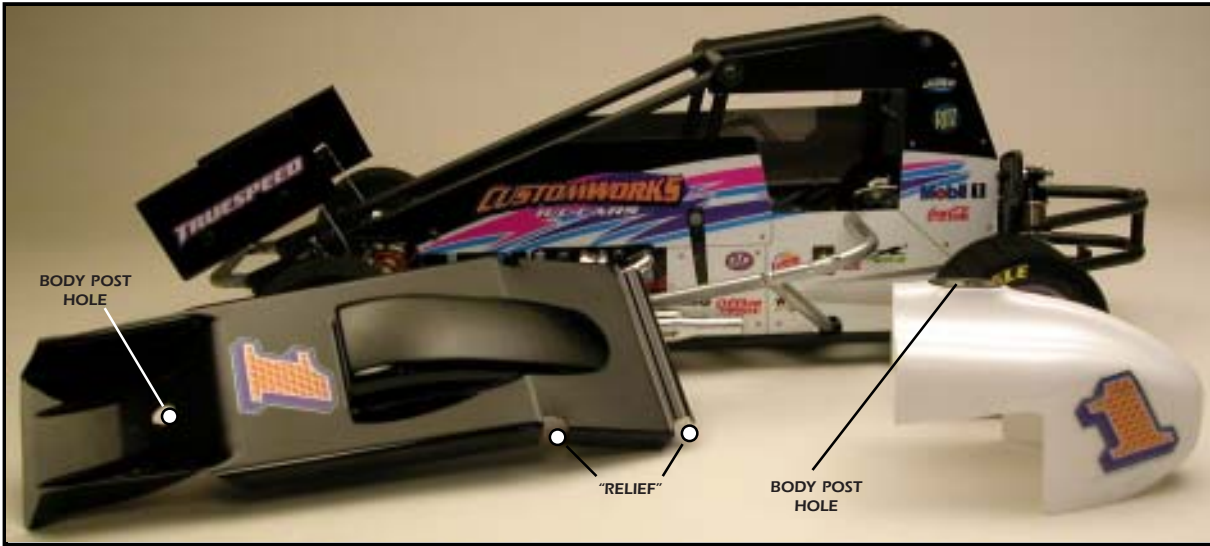

- Do these steps BEFORE painting your body panels!!!

- Follow the molded lines on the Headers, 9086 Salem Hood and 9026 Tail Tank to cut the parts out. The locations of the body lines are very accurate and will provide for the best result.

-Mounting the HEADERS: Mount the headers to the side panel using the screws and nuts provided as shown.

-Mounting the HOOD: Ream the hole marked in the hood for the body post to mount thru. Tuck the front "scoop" portion of the hood down between the front edges of the cage and onto the body post. Then align one side of the hood's edges between the cage and the body side panel. The down tubes of the cage will align into the "Relief" made in each side of the hood as noted. It will be necessary and ok to slightly bend the portion of the hood behind the hood scoop to tuck this in between the cage rails. Retain the hood at the front by using a body clip thru the body post.

-Mounting the TAIL TANK: Ream the hole marked in the fuel cap area as shown in the picture. Adjust the height of the body post collar so that the bottom of the tail tank is parallel to the ground to attain the proper look. Retain using a body clip.



Top Wing

- Assemble the #9052 Wing Kit using the instructions provided inside the wing kit. Mount the wing to the car and it should now look just like the car shown below.



CONGRATULATIONS!!! You have now completed the assembly process of your new Custom Works Enforcer GBX3! In the next section of this manual you will find some basic setup hints and advice. It is important to remember that all tracks and racing surfaces are different. Therefore the suggestions we give you are general in nature and should by no means be treated as the only options.

MAINTENANCE:

Occasionally dirt will get into the moving and pivoting locations in your car. It is best to periodically clean your car to keep all the suspension components moving freely. Read the tips below to keep your car running at its best!

- Begin by removing the majority of the dirt using a small brush, toothbrush, or compressed air.
- Compressed air is ok to use, be mindful to not FORCE the dirt into the radio gear, transmission, bearings, or air filter. Typically these items only have dirt on them, hitting the dirt with the compressed air puts dirt ***IN*** these parts!
- Tires, either foam or rubber are best cleaned using water or cleaners like Simple Green (TM). Simple Green also does a great job cleaning car parts as well. Lightly spraying car parts (NOT radio components, transmission, air filter, or bearings) with Simple Green and blowing off with compressed air or wiping the parts using the paint brush is a great way to clean in a hurry.
- Another R/C friendly cleaner is WD-40 (TM). After the car is clean, very lightly spray the car components and bearings (NOT radio components, transmission, or air filter). Use your brush or compressed air to remove the extra WD-40. This will lube your bearings and leave a protective coating on the parts making it easier to remove dirt later.
- Differential Maintenance is needed when the action of the diff feels “notchy”. Usually cleaning the diff parts, re-sand the thrust and diff plates with 400 paper, and lube appropriately will be all that is needed to bring back to new. Ignoring your differential will lead to handling woes and increase transmission temps, which will cause part failure.

TUNING TIPS: These are some general guidelines for optimizing handling performance. None of these “tips” are EVER set in stone. On any given day this manual or any chassis engineering book or guru can be proved wrong by the stop watch. A good way to approach chassis set-up is to try one change, practice it, think how the car felt different from before, and compare lap times from the stop watch.....this will never fail.

<u>Car Pushes (understeers):</u>	<u>Car Is Loose (oversteers):</u>	<u>Car Is Erratic:</u>
<ul style="list-style-type: none"> - Decrease Wing Angle - Decrease Spoiler on Wing - Heavier Rear Spring - Softer Front Spring - Use Rear Sway Bar - Try Softer Front Compound Tire - Try Harder Rear Compound Tire - Lower Front Ride Height - Raise Rear Ride Height - Thread Shock Collar UP on Right Front - Thread Shock Collar DOWN on Right Rear - Decrease Rear Toe - Decrease Castor - Add Rear Toe Stagger or Increase the difference 	<ul style="list-style-type: none"> - Increase Wing Angle - Add Spoiler to Wing - Softer Rear Spring - Heavier Front Spring - Use Front Sway Bar - Try Harder Front Compound Tire - Try Softer Rear Compound Tire - Raise Front Ride Height - Lower Rear Ride Height - Thread Shock Collar DOWN on Right Front - Thread Shock Collar UP on Right Rear - Increase Rear Toe - Increase Castor - Decrease Rear Toe Stagger or Decrease the difference 	<ul style="list-style-type: none"> - Bent Suspension Pins: Remove shocks to check free movement. - Bound Ball Joint: Should spin free on balls while mounted to the car. - Bent or Loose Camber Links - Wore out Bearings or Completely Seized Bearings - Chunked Tire: Check to see if Foam or Rubber Tire is still glued to wheel. - Loose Screws: Especially Chassis Screws, add Blue Loctite to prevent. - Shocks: Either Bound-up or Out of Oil. Must swivel freely on mounts. - Foreign Objects: Unlucky Dirt/Stones preventing Suspension or Steering Movement. - Blown Differential - Radio Problem: Bad Servo, Weak Servo Saver Spring, Transmitter Pot blown.

SET-UP GUIDELINES:

When looking for the "perfect set-up" it is important to remember 2 things...

- 1) Keeping things simple is best.
- 2) As you are making your set-up change, the track is changing too! Ask a local racer what the track usually does from beginning to end, especially day to night.
 - Start your car's ride height with it equal at all four corners to start. Use the shock collars to adjust ride height by measuring the distance under the chassis when the car is sitting on a FLAT & LEVEL surface.
 - Shock collars can only jack weight and adjust the car's handling when the car makes ALL 4 shocks squat when the car is set down. Use the RF shock collar to adjust how the car ENTERS the corner. Use the RR shock collar to adjust how the car exits the corner ON-POWER. Use the LF shock collar to make the car turn in less, and off the corner more.
 - It is best to have a little bit of brake drag when you let off the gas, this will allow for a more controllable car in ALL conditions. Increasing how much the brake drags will make your car turn into the corner harder.

SET-UP GLOSSARY:

caster: Angle of the kingpin in relation to a vertical plane as viewed from the side of the car. Increasing the angle will make the car more stable out of the turn and down the straights and increase steering entering a turn. Decreasing the angle will make the car feel more "touchy" at high speeds and help steering while exiting the turn.

Camber Gain: Angle of the Camber Link relative to the Suspension Arm. Lowering the camber link on the shock tower OR raising the camber link on the castor block will INCREASE the camber angle of the tire when the suspension is compressed. Raising the camber link on the shock tower OR lowering the camber link on the castor block will DECREASE the camber angle of the tire when the suspension is compressed. There is not a "correct" set-up and once again too much of anything is generally bad. This will help change the "feel" of the car thru the turns.

Camber Link Length: Comparing this to the length of the Suspension Arm from each pivot point and keeping the Camber the same, making the link *shorter* will decrease traction for that corner of the car while making it *longer* will increase traction for that corner of the car. Once the camber link is equal to or greater than the Suspension Arm pivots, the gain of traction ends. Also a shorter camber link will increase camber gain and a longer decrease camber gain.

Shock Angle: Leaning the shock toward the car is effectively like changing to a *softer* spring. Standing the shock closer to vertical is effectively like changing to a *stiffer* spring. Try when the car is working well and when one spring change is TOO much for your set-up.

Ride Height: Check by pushing the chassis down once or twice to simulate bumps on the track. Having the front end *higher* than the rear will make the car increase rear traction especially out of the turn. Having the front end *lower* than the front will make the car increase front traction especially entering the turn. Generally its safe to start the car with the ride heights even.

Rear Toe-In: Front edge of car tires point *toward* the chassis as viewed from above the car. Increasing the angle toward the car will increase rear traction while decreasing front traction. Decreasing the angle will do the opposite.

Rear Toe Stagger: Difference in the amount of Rear Toe-In among the rear tires. Typically used only on high bite tracks with MORE toe-in on the Left Rear tire than the Right so the rear of the car helps turn the car LEFT under acceleration.

Wheelbase (Front End): Wheelbase is the distance between the front and rear axles. Running the entire front end assembly in the forward position makes the wheelbase longer and therefore more stable on long/fast tracks with flowing turns. Running the entire front end assembly in the rear position make the wheelbase shorter and therefore more suitable for short-tracks where you are constantly turning.

Wheelbase (Rear End): This adjustment uses the plastic spacers on the kingpin the rear bearing carrier rides on. With the spacers in front of the carrier it will lengthen the wheelbase but will increase steering. If the spacers are behind the carrier it will shorten the wheelbase but increase rear traction. This is completely backwards from how it works for the Front End only because in the rear of the car you have the weight of the motor and the torque it creates. Shortening the wheelbase here makes more of the car hang over the rear tires and promotes more weight transfer.

Final Drive Chart: The chart provided below gives you the final drive of the motor to spin the axle 1 revolution. This chart is NOT just the pinion and spur, but has the transmission ratio included as well.

- To determine the final drive in your car:

- 1) Divide the Spur Gear by the Pinion Gear, which equals a "Ratio".
- 2) Multiply the "Ratio" by the "Transmission Ratio" which will equal your "Final Drive".

Transmission Ratio = 2.4 for this car.

- Gearing choice can vary greatly depending on track size, surface type, amount of traction, you motor and driving style. For starters consult your local hobby dealer or fellow racer at your local track for the ideal gear choice for your application.

64 Pitch Pinion	Spur Gear							
	78	81	85	88	93	96	100	104
16	11.70	12.15	12.75	13.20	13.95	14.40	15.00	15.60
17	11.01	11.44	12.00	12.42	13.13	13.55	14.12	14.68
18	10.40	10.80	11.33	11.73	12.40	12.80	13.33	13.87
19	9.85	10.23	10.74	11.12	11.75	12.13	12.63	13.14
20	9.36	9.72	10.20	10.56	11.16	11.52	12.00	12.48
21	8.91	9.26	9.71	10.05	10.63	10.97	11.43	11.89
22	8.51	8.84	9.27	9.60	10.15	10.47	10.91	11.35
23	8.14	8.45	8.87	9.18	9.70	10.02	10.43	10.85
24	7.80	8.10	8.50	8.80	9.30	9.60	10.00	10.40
25	7.49	7.78	8.16	8.45	8.93	9.22	9.60	9.98
26	7.20	7.48	7.85	8.12	8.58	8.85	9.23	9.60
27	6.93	7.20	7.56	7.82	8.27	8.53	8.89	9.24
28	6.69	6.94	7.29	7.54	7.97	8.23	8.57	8.91
29	6.46	6.70	7.03	7.28	7.70	7.94	8.28	8.61
30	6.24	6.48	6.80	7.04	7.44	7.68	8.00	8.32
31	6.04	6.27	6.58	6.81	7.20	7.43	7.74	8.05
32	5.85	6.08	6.38	6.60	6.98	7.20	7.50	7.80
33	5.67	5.89	6.18	6.40	6.76	6.98	7.27	7.56
34	5.51	5.72	6.00	6.21	6.56	6.78	7.06	7.34
35	5.35	5.55	5.83	6.03	6.38	6.58	6.86	7.13
36	5.20	5.40	5.67	5.87	6.20	6.40	6.67	6.93
37	5.06	5.25	5.51	5.71	6.03	6.23	6.49	6.75
38	4.93	5.12	5.37	5.56	5.87	6.06	6.32	6.57
39	4.80	4.98	5.23	5.42	5.72	5.91	6.15	6.40
40	4.68	4.86	5.10	5.28	5.58	5.76	6.00	6.24
41	4.57	4.74	4.98	5.15	5.44	5.62	5.85	6.09
42	4.46	4.63	4.86	5.03	5.31	5.49	5.71	5.94
43	4.35	4.52	4.74	4.91	5.19	5.36	5.58	5.80
44	4.25	4.42	4.64	4.80	5.07	5.24	5.45	5.67
45	4.16	4.32	4.53	4.69	4.95	5.12	5.33	5.55
46	4.07	4.23	4.43	4.59	4.85	5.01	5.22	5.43
47	3.98	4.14	4.34	4.49	4.75	4.90	5.11	5.31

48 Pitch Pinion	Spur Gear							
	66	68	70	72	75	78	81	84
12	13.20	13.60	14.00	14.40	15.00	15.60	16.20	16.80
13	12.18	12.55	12.92	13.29	13.85	14.40	14.95	15.51
14	11.31	11.66	12.00	12.34	12.86	13.37	13.89	14.40
15	10.56	10.88	11.20	11.52	12.00	12.48	12.96	13.44
16	9.90	10.20	10.50	10.80	11.25	11.70	12.15	12.60
17	9.32	9.60	9.88	10.16	10.69	11.01	11.44	11.86
18	8.80	9.07	9.33	9.60	10.00	10.40	10.80	11.20
19	8.34	8.59	8.84	9.09	9.47	9.85	10.23	10.61
20	7.92	8.16	8.40	8.64	9.00	9.36	9.72	10.08
21	7.54	7.77	8.00	8.23	8.57	8.91	9.26	9.60
22	7.20	7.42	7.64	7.85	8.18	8.51	8.84	9.16
23	6.89	7.10	7.30	7.51	7.83	8.14	8.45	8.77
24	6.60	6.80	7.00	7.20	7.50	7.80	8.10	8.40
25	6.34	6.53	6.72	6.91	7.20	7.49	7.78	8.06
26	6.09	6.28	6.46	6.65	6.92	7.20	7.48	7.75
27	5.87	6.04	6.22	6.40	6.67	6.93	7.20	7.47
28	5.66	5.83	6.00	6.17	6.43	6.69	6.94	7.20
29	5.46	5.63	5.79	5.96	6.21	6.46	6.70	6.95
30	5.28	5.44	5.60	5.76	6.00	6.24	6.48	6.72
31	5.11	5.26	5.42	5.57	5.81	6.04	6.27	6.50
32	4.95	5.10	5.25	5.40	5.63	5.85	6.08	6.30
33	4.80	4.95	5.09	5.24	5.45	5.67	5.89	6.11
34	4.66	4.80	4.94	5.08	5.29	5.51	5.72	5.93
35	4.53	4.66	4.80	4.94	5.14	5.35	5.55	5.75





DRIVER: _____ Clay Hard Packed Loose Dirt
 DATE: _____ Carpet Asphalt Concrete
 EVENT: _____ Flat Banked True Oval Tri-Oval
 CLASS: _____ Traction: High Medium Low
 TRACK: _____ LENGTH: _____

RIGHT FRONT SUSPENSION LEFT

CAMBER: _____	TOE IN/OUT AMOUNT: _____	RF <input type="checkbox"/> LEAD <input type="checkbox"/> TRAIL AMOUNT: _____	CAMBER: _____
CAMBER LINK LOCATION <input type="checkbox"/> OUTER <input type="checkbox"/> INNER	SHOCK POSITION: <input type="checkbox"/> TOP <input type="checkbox"/> MID <input type="checkbox"/> BOT		CAMBER LINK LOCATION <input type="checkbox"/> OUTER <input type="checkbox"/> INNER
CAMBER RATE SHIMS: _____			CAMBER RATE SHIMS: _____
KINGPIN INCLINE <input type="checkbox"/> 0° <input type="checkbox"/> ANGLED			KINGPIN INCLINE <input type="checkbox"/> 0° <input type="checkbox"/> ANGLED
ACKERMANN: <input type="checkbox"/> ON SPINDLE <input type="checkbox"/> SHORT <input type="checkbox"/> MIDDLE <input type="checkbox"/> LONG	SUSPENSION POSITION RF: <input type="checkbox"/> OUTER <input type="checkbox"/> MIDDLE <input type="checkbox"/> INNER LF: <input type="checkbox"/> OUTER <input type="checkbox"/> MIDDLE <input type="checkbox"/> INNER	ACKERMANN: <input type="checkbox"/> ON SPINDLE <input type="checkbox"/> SHORT <input type="checkbox"/> MIDDLE <input type="checkbox"/> LONG	
FRONT AXLE: <input type="checkbox"/> STOCK <input type="checkbox"/> EXTENDED	CASTOR: <input type="checkbox"/> 0° <input type="checkbox"/> +5° <input type="checkbox"/> -5° <input type="checkbox"/> +10° <input type="checkbox"/> -10°	KICK-UP: <input type="checkbox"/> 25° <input type="checkbox"/> 20° HIGH <input type="checkbox"/> 20° LO <input type="checkbox"/> 15° HIGH <input type="checkbox"/> 15° LO	FRONT AXLE: <input type="checkbox"/> STOCK <input type="checkbox"/> EXTENDED
AXLE SHIMS: _____	SWAY BAR: <input type="checkbox"/> NONE <input type="checkbox"/> .063" <input type="checkbox"/> .078"		AXLE SHIMS: _____

SHOCKS



LEFT FRONT SHOCK	RIGHT FRONT SHOCK
BODY LENGTH <input type="checkbox"/> SHORT <input type="checkbox"/> MED <input type="checkbox"/> LONG	BODY LENGTH <input type="checkbox"/> SHORT <input type="checkbox"/> MED <input type="checkbox"/> LONG
SHAFT LENGTH <input type="checkbox"/> SHORT <input type="checkbox"/> MED <input type="checkbox"/> LONG	SHAFT LENGTH <input type="checkbox"/> SHORT <input type="checkbox"/> MED <input type="checkbox"/> LONG
SPRING: _____	SPRING: _____
OIL: _____ PISTON: _____	OIL: _____ PISTON: _____
BLADDER: _____	BLADDER: _____
LENGTH: _____	LENGTH: _____
COLLAR: _____	COLLAR: _____
LEFT REAR SHOCK	RIGHT REAR SHOCK
BODY LENGTH <input type="checkbox"/> SHORT <input type="checkbox"/> MED <input type="checkbox"/> LONG	BODY LENGTH <input type="checkbox"/> SHORT <input type="checkbox"/> MED <input type="checkbox"/> LONG
SHAFT LENGTH <input type="checkbox"/> SHORT <input type="checkbox"/> MED <input type="checkbox"/> LONG	SHAFT LENGTH <input type="checkbox"/> SHORT <input type="checkbox"/> MED <input type="checkbox"/> LONG
SPRING: _____	SPRING: _____
OIL: _____ PISTON: _____	OIL: _____ PISTON: _____
BLADDER: _____	BLADDER: _____
LENGTH: _____	LENGTH: _____
COLLAR: _____	COLLAR: _____

LEFT REAR SUSPENSION RIGHT

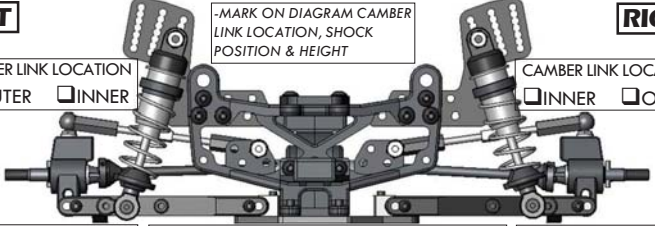
CAMBER LINK LOCATION <input type="checkbox"/> OUTER <input type="checkbox"/> INNER		CAMBER LINK LOCATION <input type="checkbox"/> INNER <input type="checkbox"/> OUTER
HUB SPACING: SHADE IN 4 SPACERS FOOOOOOOOR		HUB SPACING: SHADE IN 4 SPACERS FOOOOOOOOR
CAMBER: _____	SWAY BAR: <input type="checkbox"/> NONE <input type="checkbox"/> .063" <input type="checkbox"/> .078"	CAMBER: _____
TOE-IN: _____	REAR WIDTH (INNER/OUTER) LR: _____ RR: _____	TOE-IN: _____
WHEEL SPACERS: _____	ANTI-SQUAT SHIMS: LR: _____ RR: _____	WHEEL SPACERS: _____

WEIGHT & CHASSIS HEIGHTS

ADDED LEAD: FRONT _____ MIDDLE _____ REAR _____	SPEED CONTROL <input type="checkbox"/> AS SHOWN <input type="checkbox"/> IN TAIL TANK
RECIEVER <input type="checkbox"/> AS SHOWN <input type="checkbox"/> _____	BATTERY LOCATION BY HOLE POSITION FRONT <input type="checkbox"/> <input type="checkbox"/> <input type="checkbox"/> <input type="checkbox"/> REAR
CORNER WEIGHTS: LF: _____ RF: _____ LR: _____ RR: _____	CHASSIS HEIGHTS BY LOCATION: ① _____ ② _____ ③ _____ ④ _____
OVERALL WEIGHT: _____	MEASURED FROM: <input type="checkbox"/> TOP OF CHASSIS <input type="checkbox"/> BOTTOM OF CHASSIS

TIRES & TRACTION

TIRE TYPE: <input type="checkbox"/> FOAM <input type="checkbox"/> STREET RUBBER <input type="checkbox"/> LOOSE DIRT	-SHADE IN AREAS OF TRACTION ADDITIVE AND DRAW IN TIRE GROOVES	
COMPOUND _____ DIAMETER _____ INSERT _____	LF	RF
RF: _____		
LF: _____		
RR: _____		
LR: _____		
TRACTION ADDITIVE: _____	LR	RR

WING

MAIN WING SIZE: 6X6 7X7
 FRONT WING SIZE: _____
 SPOILER LENGTH: _____
 WING LOCATION: _____

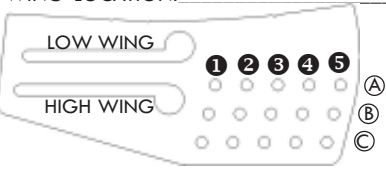

HOOD TYPE: _____

MISC...

MOTOR: _____
 PINION: _____ SPUR: _____
 SPEED CONTROL: _____
 PUNCH SETTING: _____
 INTIAL BRAKE: _____
 AUTO BRAKE: _____